

DMP 321

Industrial Pressure Transmitter

Stainless Steel Sensor

accuracy according to IEC 60770:
standard: 0.25 % FSO
option: 0.1 % FSO



Nominal pressure

from 0 ... 100 mbar up to 0 ... 600 bar

Output signals

2-wire: 4 ... 20 mA

3-wire: 0 ... 20 mA / 0 ... 10 V

others on request

Special characteristics

- ▶ perfect thermal behaviour
- ▶ excellent long-term stability
- ▶ compact design

Optional versions





- ▶ IS-version
Ex ia = intrinsically safe for gases and dusts
- ▶ welded pressure sensor
- ▶ customer specific versions

The pressure transmitter DMP 321 is the consistent further development of our in many applications approved DMP 331. It shows an improved signal behaviour and sets new standards in the industrial class.

Its metallic diaphragm made of stainless steel (1.4435 / 316L) offers a good corrosion resistance in many industrial processes.

The modular device concept allows to combine different pressure ranges with a variety of electrical and mechanical connections. Thus a diversity of variations is created, meeting almost all requirements in industrial applications.

Preferred areas of use are

-  Plant and machine engineering
-  Environmental engineering
-  Energy industry
-  Mobile hydraulics



Input pressure range												
Nominal pressure gauge	[bar]	-1...0	0.10	0.16	0.25	0.40	0.60	1	1.6	2.5	4	6
Nominal pressure abs.	[bar]	-	-	-	-	0.40	0.60	1	1.6	2.5	4	6
Overpressure	[bar]	5	0.5	1	1	2	5	5	10	10	20	40
Burst pressure \geq	[bar]	7.5	1.5	1.5	1.5	3	7.5	7.5	15	15	25	50
Nominal pressure gauge / abs.												
	[bar]	10	16	25	40	60	100	160	250	400	600	
Overpressure	[bar]	40	80	80	105	210	600	600	1000	1000	1000	
Burst pressure \geq	[bar]	50	120	120	210	420	1000	1000	1250	1250	1800	
Vacuum resistance		$P_N \geq 1$ bar: unlimited vacuum resistance $P_N < 1$ bar: on request										
Output signal / Supply												
Standard		2-wire: 4 ... 20 mA / $V_S = 10 \dots 32 V_{DC}$										
Option IS-protection		2-wire: 4 ... 20 mA / $V_S = 10 \dots 28 V_{DC}$										
Options 3-wire		3-wire: 0 ... 20 mA / $V_S = 14 \dots 30 V_{DC}$ 0 ... 10 V / $V_S = 14 \dots 30 V_{DC}$										
Performance												
Accuracy ¹		standard: $\leq \pm 0.25$ % FSO option: $\leq \pm 0.1$ % FSO										
Permissible load		current 2-wire: $R_{max} = [(V_S - V_{S min}) / 0.02 A] \Omega$ current 3-wire: $R_{max} = 500 \Omega$ voltage 3-wire: $R_{min} = 10 k\Omega$										
Influence effects		supply: 0.05 % FSO / 10 V load: 0.05 % FSO / k Ω										
Long term stability		$\leq \pm 0.1$ % FSO / year at reference conditions										
Response time		2-wire: ≤ 10 msec 3-wire: ≤ 3 msec										
¹ accuracy according to IEC 60770 – limit point adjustment (non-linearity, hysteresis, repeatability)												
Thermal effects (Offset and Span)												
Tolerance band		$\leq \pm 0.75$ % FSO										
in compensated range		-20 ... 85 °C										
Permissible temperatures												
Permissible temperatures		medium: -40 ... 125 °C electronics / environment: -40 ... 85 °C storage: -40 ... 100 °C										
Electrical protection												
Short-circuit protection		permanent										
Reverse polarity protection		no damage, but also no function										
Electromagnetic compatibility		emission and immunity according to EN 61326										
Mechanical stability												
Vibration		10 g RMS (25 ... 2000 Hz) according to DIN EN 60068-2-6										
Shock		100 g / 11 msec according to DIN EN 60068-2-27										
Materials												
Pressure port		stainless steel 1.4404 (316 L)										
Housing		stainless steel 1.4404 (316 L)										
Option compact field housing		stainless steel 1.4305 (303), cable gland brass, nickel plated									others on request	
Seals (media wetted)		standard: FKM options: EPDM (for $P_N \leq 160$ bar) welded version ² (for $P_N \leq 40$ bar)									others on request	
Diaphragm		stainless steel 1.4435 (316 L)										
Media wetted parts		pressure port, seals, diaphragm										
² welded version only with pressure ports according to EN 837, $P_N \leq 40$ bar												
Explosion protection (only for 4 ... 20 mA / 2-wire)												
Approvals DX19-DMP 321		IBEExU 10 ATEX 1068 X / IECEx IBE 12.0027X zone 0: II 1G Ex ia IIC T4 Ga zone 20: II 1D Ex ia IIIC T 85°C Da										
Safety technical maximum values		$U_i = 28 V_{DC}$, $I_i = 93$ mA, $P_i = 660$ mW, $C_i \approx 0$ nF, $L_i \approx 0$ μ H, the supply connections have an inner capacity of max. 27 nF to the housing										
Ambient temperature range		in zone 0: -20 ... 60 °C with p_{atm} 0.8 bar up to 1.1 bar in zone 1 or higher: -20 ... 70 °C										
Connecting cables (by factory)		cable capacitance: signal line/shield also signal line/signal line: 160 pF/m cable inductance: signal line/shield also signal line/signal line: 1 μ H/m										

DMP 321

Industrial Pressure Transmitter

Technical Data

Miscellaneous		
Current consumption	signal output current: max. 25 mA	signal output voltage: max. 7 mA
Weight	approx. 140 g	
Installation position	any ³	
Operational life	100 million load cycles	
CE-conformity	EMC Directive: 2014/30/EU	Pressure Equipment Directive: 2014/68/EU (module A) ⁴
ATEX Directive	2014/34/EU	

³ Pressure transmitters are calibrated in a vertical position with the pressure connection down. If this position is changed on installation there can be slight deviations in the zero point for pressure ranges $P_N \leq 1$ bar.

⁴ This directive is only valid for devices with maximum permissible overpressure > 200 bar

Wiring diagrams

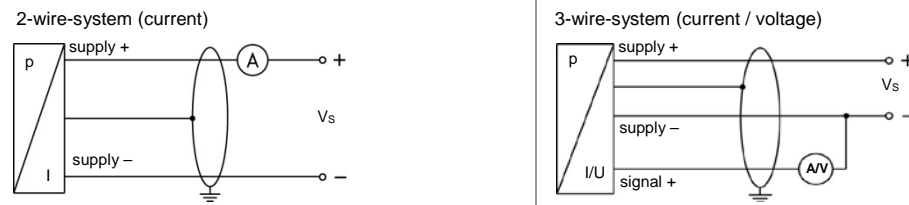

Pin configuration

Electrical connection	ISO 4400	Binder 723 (5-pin)	M12x1/metal (4-pin)	Bayonet MIL-C-26482 (10-6)		field housing	cable colours (IEC 60757)
				2-wire	3-wire		
Supply +	1	3	1	A	A	IN +	wh (white)
Supply -	2	4	2	B	D	IN -	bn (brown)
Signal + (for 3-wire)	3	1	3	-	B	OUT +	gn (green)
Shield	ground pin	5	4	pressure port		⊥	gnye (green-yellow)

Electrical connections (dimensions in mm)

standard

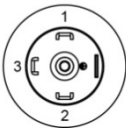
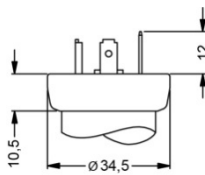

ISO 4400 (IP 65)

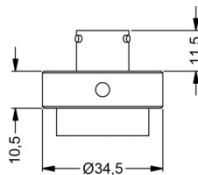

Bayonet MIL-C-26482 (10-6) (IP 67)

option

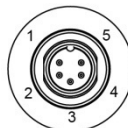
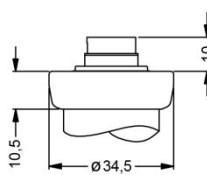

Binder Series 723 5-pin (IP 67)

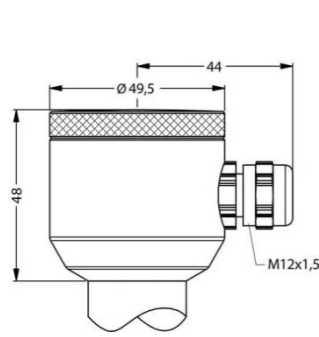

compact field housing (IP 67)

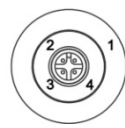
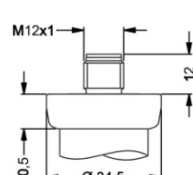

M12x1 4-pin (IP 67)

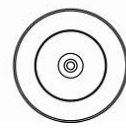
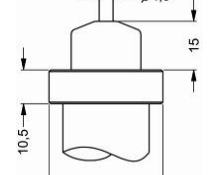

cable outlet with PVC cable (IP 67)⁵

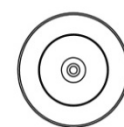
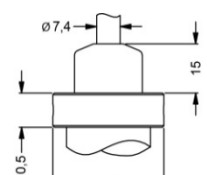

cable outlet, cable with ventilation tube (IP 68)⁶

⇒ universal field housing stainless steel 1.4404 (316 L) with cable gland M20x1.5 (ordering code 880) and other versions on request

⁵ standard: 2 m PVC cable without ventilation tube (permissible temperature: -5 ... 70 °C)

⁶ different cable types and lengths available, permissible temperature depends on kind of cable

Mechanical connections (dimensions in mm)

standard

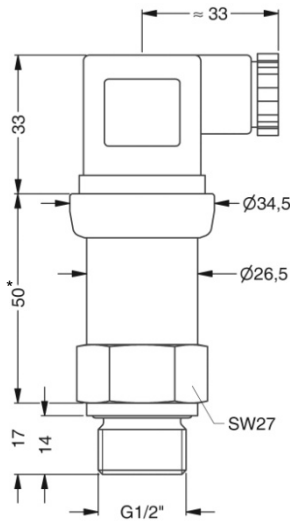

G1/2" DIN 3852
with ISO 4400

option

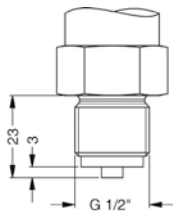

G1/2" EN 837

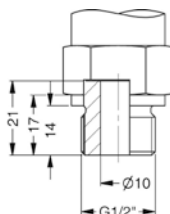

G1/2" DIN 3852
open port, P_N ≤ 40 bar

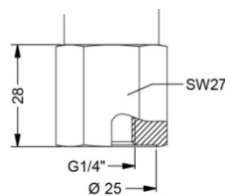

G1/4" DIN 3852
internal thread

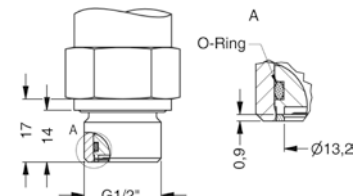

G1/2" DIN 3852
with flush sensor, P_N ≤ 40 bar

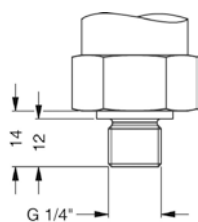

G1/4" DIN 3852

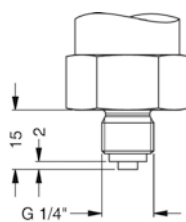

G1/4" EN 837

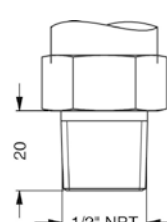

1/2" NPT

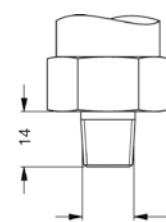

1/4" NPT

⇒ **metric threads and other versions on request**

* for nominal pressure P_N > 60 bar increases the length of devices by 9 mm;
with electrical connection Bayonet MIL-C-26482 (10-6) increases the length of devices by 5 mm additionally

© 2018 BDISENSORS GmbH – The specifications given in this document represent the state of engineering at the time of publishing. We reserve the right to make modifications to the specifications and materials.

Ordering code DMP 321

DMP 321

□□□ - □□□□ - □ - □ - □□□ - □□□□ - □ - □□□

Pressure									
	gauge	1	1	5					
	absolute ¹	1	1	6					
Input									
	[bar]								
	0.10 ¹	1	0	0	0				
	0.16 ¹	1	6	0	0				
	0.25 ¹	2	5	0	0				
	0.40	4	0	0	0				
	0.60	6	0	0	0				
	1.0	1	0	0	1				
	1.6	1	6	0	1				
	2.5	2	5	0	1				
	4.0	4	0	0	1				
	6.0	6	0	0	1				
	10	1	0	0	2				
	16	1	6	0	2				
	25	2	5	0	2				
	40	4	0	0	2				
	60	6	0	0	2				
	100	1	0	0	3				
	160	1	6	0	3				
	250	2	5	0	3				
	400	4	0	0	3				
	600	6	0	0	3				
	-1 ... 0	X	1	0	2				
	customer	9	9	9	9				consult
Output									
	4 ... 20 mA / 2-wire					1			
	0 ... 20 mA / 3-wire					2			
	0 ... 10 V / 3-wire					3			
	Intrinsic safety 4 ... 20 mA / 2-wire					E			
	customer					9			consult
Accuracy									
	standard	0.25 %				2			
	option	0.1 %				1			
	customer					9			consult
Electrical connection									
	Male and female plug ISO 4400					1	0	0	
	Male plug Binder series 723 (5-pin)					2	0	0	
	Cable outlet with PVC cable ²					T	A	0	
	Cable outlet ³					T	R	0	
	Male plug M12x1 (4-pin) / metal					M	1	0	
	Bayonet MIL-C-26482 (10-6); 2 wire					B	G	0	
	Bayonet MIL-C-26482 (10-6); 3 wire					B	G	4	
	Compact field housing					8	5	0	
	stainless steel 1.4305								
	customer					9	9	9	consult
Mechanical connection									
	G1/2" DIN 3852					1	0	0	
	G1/2" EN 837					2	0	0	
	G1/4" DIN 3852					3	0	0	
	G1/4" DIN 3852, internal thread					J	0	0	
	G1/4" EN 837					4	0	0	
	G1/2" DIN 3852					F	0	0	
	with flush sensor ⁴								
	G1/2" DIN 3852 open pressure port ⁴					H	0	0	
	1/2" NPT					N	0	0	
	1/4" NPT					N	4	0	
	customer					9	9	9	consult
Seals									
	FKM							1	
	EPDM							3	
	without (welded version) ⁵							2	
	customer							9	consult
Special version									
	standard							0	0
	customer							9	9

¹ absolute pressure possible from 0.4 bar

² standard: 2 m PVC cable without ventilation tube (permissible temperature: -5 ... 70 °C), optionally without ventilation tube

³ cable with ventilation tube (code TR0 = PVC cable), different cable types and lengths available, permissible temperature depends on kind of cable, price without cable

⁴ not possible for nominal pressure $P_N > 40$ bar

⁵ welded version only with pressure ports according to EN 837, possible for $P_N \leq 40$ bar

