

Operating Manual

Electronic Pressure Switch DS 2XX

DS 200, DS 200 P, DS 201, DS 201 P, DS 202, DS 210, DS 214, DS 217, DS 233



READ THOROUGHLY BEFORE USING THE DEVICE
KEEP FOR FUTURE REFERENCE

ID: BA_DS2XX_E | Version: 04.2020.1

© 2020 BD|SENSORS GmbH - All rights reserved.

1. General and safety-related information on this operating manual

This operating manual enables safe and proper handling of the product, and forms part of the device. It should be kept in close proximity to the place of use, accessible for staff members at any time.

All persons entrusted with the mounting, installation, putting into service, operation, maintenance, removal from service, and disposal of the device must have read and understood the operating manual and in particular the safety-related information.

Complementary to this operating manual the current data sheet has to be adhered to.

Download this by accessing www.bdsensors.de or request it: info@bdsensors.de phone: +49 (0) 92 35 / 98 11 0

In addition, the applicable accident prevention regulations, safety requirements, and country-specific installation standards as well as the accepted engineering standards must be observed.

1.1 Symbols used

	<ul style="list-style-type: none"> Type and source of danger Measures to avoid the danger
--	---

Warning word	Meaning
	<ul style="list-style-type: none"> Imminent danger! Non-compliance will result in death or serious injury.
	<ul style="list-style-type: none"> Possible danger! Non-compliance may result in death or serious injury.
	<ul style="list-style-type: none"> Hazardous situation! Non-compliance may result in minor or moderate injury.

NOTE - draws attention to a possibly hazardous situation that may result in property damage in case of non-compliance.

✓ Precondition of an action

1.2 Staff qualification

Qualified persons are persons that are familiar with the mounting, installation, putting into service, operation, maintenance, removal from service, and disposal of the product and have the appropriate qualification for their activity.

This includes persons that meet at least one of the following three requirements:

- They know the safety concepts of metrology and automation technology and are familiar therewith as project staff.
- They are operating staff of the measuring and automation systems and have been instructed in the handling of the systems. They are familiar with the operation of the devices and technologies described in this documentation.
- They are commissioning specialists or are employed in the service department and have completed training that qualifies them for the repair of the system. In addition, they are authorized to put into operation, to ground, and to mark circuits and devices according to the safety engineering standards.

All work with this product must be carried out by qualified persons!

1.3 Intended use

The **electronic pressure switch DS 2XX** has been developed, according to the type for applications, for absolute, vacuum and overpressure measurement. It is equipped with a 4-digit LED-display to show the current system pressure. Depending on the device and the mechanical connection it is suitable for various areas of use.

The user must check whether the device is suited for the selected use. In case of doubt, please contact our sales department: info@bdsensors.de | phone: +49 (0) 92 35 98 11 0 BD|SENSORS assumes no liability for any wrong selection and the consequences thereof!

The media that can be measured are gases and liquids that are compatible with the materials in contact with the fluids, described in the data sheet. This must be ensured for the application.

The technical data listed in the current data sheet are engaging and must absolutely be complied with. If the data sheet is not available, please order or download it from our homepage: <http://www.bdsensors.de>

	<p>Danger through incorrect use</p> <ul style="list-style-type: none"> In order to avoid accidents, use the device only in accordance with its intended use.
--	--

1.4 Limitation of liability and warranty

Failure to observe the instructions or technical regulations, improper use and use not as intended, and alteration of or damage to the device will result in the forfeiture of warranty and liability claims.

1.5 Safe handling

NOTE - Do not use any force when installing the device to prevent damage of the device and the plant!

NOTE - Treat the device with care both in the packed and unpacked condition!

NOTE - The device must not be altered or modified in any way.

NOTE - Do not throw or drop the device!

NOTE - Excessive dust accumulation (over 5 mm) and complete coverage with dust must be prevented!

NOTE - The device is state-of-the-art and is operationally reliable. Residual hazards may originate from the device if it is used or operated improperly.

1.6 Scope of delivery

Check that all parts listed in the scope of delivery are included free of damage, and have been delivered according to your purchase order:

- electronic pressure switch
- for mechanical pressure ports DIN 3852: O-Ring (pre-mounted)
- this operating manual

1.7 UL approval (for devices with UL Marking)

The UL approval was effected by applying the US standards, which also conform to the applicable Canadian standards on safety.

Observe the following points so that the device meets the requirements of the UL approval:

- only indoor usage
- maximum operating voltage: according to data sheet
- The device must be operated via a supply with energy limitation (acc. to UL 61010) or an NEC Class 2 energy supply.

2. Product identification

The device can be identified by means of the manufacturing label with ordering code. The most important data can be gathered therefrom. The version of the firmware, (e. g. P07) will appear for about 1 second in the display after starting up the device. Please hold it ready for inquiry calls.

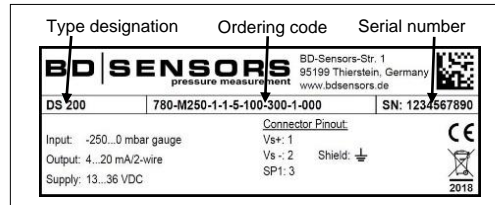

Fig. 1 example of manufacturing label

NOTE - The manufacturing label must not be removed!

3. Mounting

3.1 Mounting and safety instructions

	<p>Danger of death from airborne parts, leaking fluid, electric shock</p> <ul style="list-style-type: none"> Always mount the device in a depressurized and de-energized condition!
	<p>Danger of death from improper installation</p> <ul style="list-style-type: none"> Installation must be performed only by appropriately qualified persons who have read and understood the operating manual.

NOTE - If there is increased risk of damage to the device by lightning strike or overvoltage, increased lightning protection must additionally be provided!

NOTE - Do not remove the packaging or protective caps of the device until shortly before the mounting procedure, in order to exclude any damage to the diaphragm! Protective caps must be kept! Dispose of the packaging properly!

NOTE - Treat any unprotected diaphragm with utmost care; this can be damaged very easily.

NOTE - The display module and the plastic housing are equipped with rotation limiters. Please do not attempt to overtighten it by applying increased force.

NOTE - Provide a cooling line when using the device in steam piping and clarify the material compatibility.

NOTE - When installing the device, avoid high mechanical stresses on the pressure port! This will result in a shift of the characteristic curve or to damage, in particular in case of very small pressure ranges and devices with a pressure port made of plastic.

NOTE - In hydraulic systems, position the device in such a way that the pressure port points upward (ventilation).

NOTE - The specified tightening torques must not be exceeded!

NOTE - If the device is installed with the pressure port pointing upwards, ensure that no liquid drains off on the gauge. This could result in humidity and dirt blocking the gauge reference in the housing and could lead to malfunctions. Dust and dirt must be removed from the edge of the screwed joint of the electrical connection.

NOTE - Please check the conditions of use and operation of the device at regular intervals. If the properties are changed, initiate appropriate measures.

NOTES - for mounting outdoors / in a humid environment and for cleaning:

- Please note that your application does not show a dew point, which causes condensation and can damage the device. There are specially protected devices for these operating conditions. Please contact us in such case.
- Connect the device electrically straightaway after mounting or prevent moisture penetration, e.g. by a suitable protective cap. (The ingress protection specified in the data sheet applies to the connected device.)
- For devices with gauge reference in the housing (small hole next to the electrical connection), install the device in such a way, that the gauge reference is protected from dirt and moisture. Should the device be exposed to fluid admission, the functionality will be blocked by the gauge reference. An exact measurement in this condition is not possible. Furthermore, this can lead to damages on the device.
- Select the mounting position such that splashed and condensed water can drain off. Stationary liquid on sealing surfaces must be excluded!
- If the device has a cable outlet or cable gland, the outgoing cable must be routed downwards. If the cable needs to be routed upwards, this must be done in an initially downward curve.

- Mount the device such that it is protected from direct solar radiation. In the most unfavourable case, direct solar radiation leads to the exceeding of the permissible operating temperature, which can then damage the device or affect its ability to function correctly. If the internal pressure in the device rises, this could also cause temporary measurement errors.

3.2 Conditions for devices with 3-A symbol

The device or its connecting piece must be installed in such a way that the surfaces are self-draining. Make sure that the welding socket is mounted flush inside the tank.

The user is responsible for:

- the correct size of the seal and the choice of an elastomeric sealing material that complies with the 3-A standard
- defining adequate service intervals

3.3 Conditions for oxygen applications

	<p>Danger of death from explosion</p> <ul style="list-style-type: none"> when used improperly
--	---

Make sure that your device was ordered for oxygen applications and delivered accordingly. (see manufacturing label - ordering code ends with the numbers "007")

Unpack the device directly prior to the installation. Skin contact during unpacking and installation must be avoided to prevent fatty residues remaining on the device. Wear safety gloves!

The entire system must meet the requirements of BAM (DIN 19247)!

For oxygen applications > 25 bar, devices without seals are recommended.

Device with o-rings of FKM (Vi 567): permissible maximum values: 25 bar / 150° C (BAM approval)

3.4 Mounting steps for connections according to DIN 3852

NOTE - Do not use any additional sealing material such as yarn, hemp or Teflon tape!

- ✓ The O-ring is undamaged and seated in the designated groove.
- ✓ The sealing face of the mating component has a flawless surface. (Rz 3.2)

- 1 Screw the device into the corresponding thread by hand.
- 2 Devices equipped with a knurled ring: only tighten by hand
- 3 Devices with a spanner flat must be tightened using a suitable open-end wrench.

- Wrench flat made of steel:
 - G1/4": approx. 5 Nm G1/2": approx. 10 Nm
 - G3/4": approx. 15 Nm G1": approx. 20 Nm
 - G1 1/2": approx. 25 Nm
- Wrench flat made of plastic: max. 3 Nm

3.5 Mounting steps for connections according to EN 837

- ✓ A suitable seal for the medium and the pressure to be measured is available. (e.g. a copper seal)
- ✓ The sealing face of the mating component has a flawless surface. (Rz 6.3)

- 1 Screw the device into the corresponding thread by hand.
- 2 Then tighten it using an open-end wrench:
 - G1/4": approx. 20 Nm; G1/2": approx. 50 Nm

NOTE - note the permitted pressure according to EN 837:

G1/4" EN 837	$p_N \leq 600$ bar	Counterpart has to be of steel according to DIN 17440 with strength $R_{p0.2} \geq 190$ N/mm ²
G1/2" EN 837	$p_N \leq 1000$ bar	
G1/4" EN 837	$p_N > 600$ bar, $p_N \leq 1000$ bar	Counterpart has to be of steel according to DIN 17440 with strength $R_{p0.2} \geq 260$ N/mm ²
G1/2" EN 837	$p_N > 1000$ bar, $p_N \leq 1600$ bar	

3.6 Mounting steps for NPT connections

- ✓ Suitable fluid-compatible sealing material, e.g. PTFE tape, is available.

- 1 Screw the device into the corresponding thread by hand
- 2 Then tighten it using an open-end wrench:
 - 1/4" NPT: approx. 30 Nm; 1/2" NPT: approx. 70 Nm

3.7 Mounting steps for G1" cone connection

- 1 Screw the device into the mating thread by hand (seal produced metalically)
- 2 Then tighten it using an open-end wrench:
 - $p_N < 10$ bar: 30 Nm; $p_N \geq 10$ bar: 60 Nm

3.8 Mounting steps for internal threads M20x1.5 and 9/16" UNF (for high-pressure devices)

	<p>Danger of injury</p> <ul style="list-style-type: none"> Due to wrong installation Do not use any seal!
--	--

NOTE - The high-pressure tube will seal metal-to-metal in the chamfer of the pressure port. (sealing cone 60°)

- 1 Screw the high-pressure fitting into the internal thread of the device.
- 2 Then tighten it using an open-end wrench. The required tightening torque depends on the manufacturer's specifications for the high-pressure pipe you are using. (permissible tightening torque for pressure switch: max 120 Nm)

3.9 Mounting steps for dairy pipe connections

- ✓ The O-ring is undamaged and seated in the designated groove.

- 1 Centre the dairy pipe connection in the counterpart.
- 2 Screw the cup nut onto the mounting part.
- 3 Then tighten it using a hook wrench.

3.10 Mounting steps for Clamp and Varivent® connections

- ✓ A suitable seal for the measured fluid and the pressure to be measured is available.
- ✓ Chapter "3.2 Conditions for devices with 3-A symbol" was noticed.

- 1 Place the seal onto the corresponding mounting part.
- 2 Centre the clamp connection or Varivent® connection above the counterpart with seal.
- 3 Then fit the device with a suitable fastening element (e. g. semi-ring or retractable ring clamp) according to the supplier's instructions

3.11 Mounting steps for DS 233

Connect the reference pressures so that the higher pressure is connected with input "p+" and the lower pressure is connected with input "p-".

Fix the device according to your demands on the holder or holding angle intended for it. For mounting the device mounting threads or holes are provided.

G 1/8" Internal thread:

- ✓ The pressure ports of the pressure switch are sealed in a way that is suitable for your application. (seals are not included in the scope of delivery)

- 1 Screw the fittings into the threads as far as possible.
- 2 Tighten the fittings properly (max. 10 Nm).

tube nozzle Ø 6.6 x 11:

Slip your flexible tubes (Ø 6 mm) onto the tube nozzles as far as possible.

3.12 Positioning of the display module

In order to ensure easy readability even when the device is installed in an awkward location, the display can be rotated into the desired position. Its rotational capability is illustrated below. Note rotation limits.

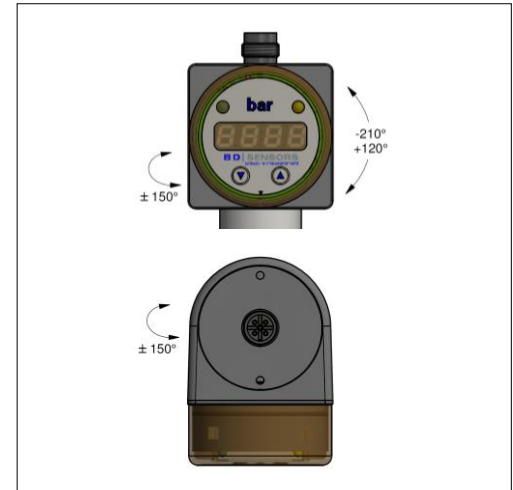

Fig. 2 display module (example with M12x1 and 2 contacts)

4. Electrical connection

4.1 Connection and safety instructions

	<p>Danger of death from electric shock</p> <ul style="list-style-type: none"> Always mount the device in a depressurized and de-energized condition!
--	--

- ✓ The supply corresponds to protection class III (protective insulation).

NOTE - For the electrical connection a shielded and twisted multicore cable is recommended.

NOTE - for devices with **plug ISO 4400**

- It must be ensured that the external diameter of the used cable is within the permissible clamping range (Ø 4 ... 6 mm). Moreover you have to ensure that it lies in the cable gland firmly and cleftlessly!
- The cable socket must be properly mounted so that the ingress protection specified in the data sheet is ensured! Ensure that the delivered seal is placed between plug and cable socket. After connecting the cable, fasten the cable socket on the device by using the screw.

NOTE - for devices with **cable outlet**

- When routing the cable, following bending radiuses have to be complied with:

- cable without ventilation tube:
 - static installation: 8-fold cable diameter
 - dynamic application: 12-fold cable diameter
- cable with ventilation tube:
 - static installation: 10-fold cable diameter
 - dynamic application: 20-fold cable diameter

- In case of devices with **cable outlet** and integrated ventilation tube, the PTFE filter located at the cable end on the ventilation tube must neither be damaged nor removed! Route the end of the cable into an area or suitable connection box which is as dry as possible and free from aggressive gases, in order to prevent any damage.

NOTE - If a transition is desired from a transmitter cable with gauge tube to a cable without gauge tube, we recommend our terminal box KL 1 or KL 2.

4.2 Electrical installation

Establish the electrical connection of the device according to the technical data shown on the manufacturing label, the following table and the wiring diagram.

Pin configuration:

Electrical connections	M12x1 plastic (5-/8-pin)	M12x1 metal (5-pin)	Binder series 723 (5-pin)
Supply +	1	1	1
Supply -	3	3	3
Signal + (only 3-wire:)	2	2	2
Contact 1	4	4	4
Contact 2	5	5	5
Contact 3	6 ¹	-	-
Contact 4	7 ¹	-	-
Shield	via pressure port	plug-housing / pressure port	

Electrical connections	ISO 4400	cable colours (IEC 60757)
Supply +	1	WH (white)
Supply -	2	BN (brown)
Signal + (only 3-wire:)	3	GN (green)
Contact 1	3	GY (grey)
Contact 2	-	PK (pink)
Shield	ground pin	GNYE (green / yellow)

¹ for 8-pin plug

Wiring diagrams:

2-wire-system (current)

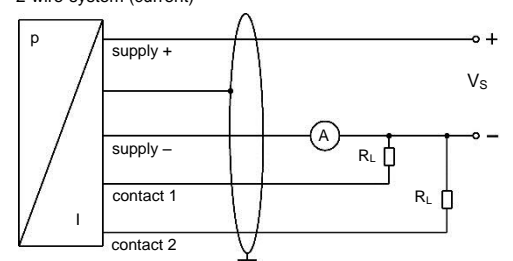

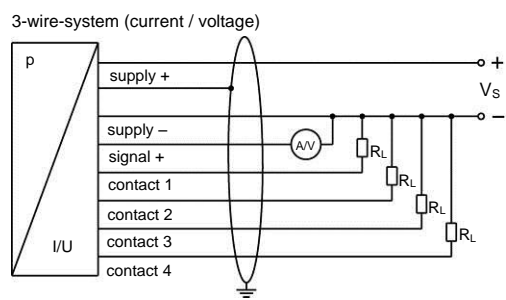

5. Commissioning

DANGER

Danger of death from airborne parts, leaking fluid, electric shock

- Operate the device only within the specification! (according to data sheet)

- ✓ The device has been installed properly.
- ✓ The device does not have any visible defect.

6. Operation

6.1 Control and display elements

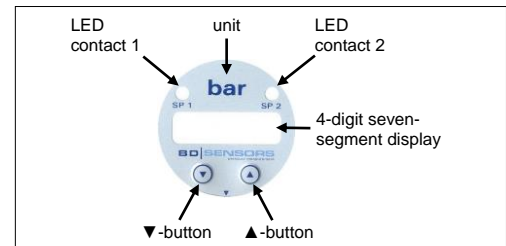

Fig. 3 touch pad (example with two contacts)

The device has, according to the order max. four LEDs which are allocated to the resp. contacts. The LEDs will light up when the respective set point has been reached and the contact is active. The display of the measured value as well as the configuration of the individual parameters occurs menu-driven via the seven-segment display.

Button functions	
	<ul style="list-style-type: none"> move forward in the menu system (beginning with menu 1) increase the displayed value note: increase the counting speed by keeping the button pushed for more than 5 second
	<ul style="list-style-type: none"> move backwards in the menu system (beginning with the last menu) decrease the displayed value note: increase the counting speed: keep the button pushed for more than 5 second
	confirm the menu items and set values by pushing both buttons simultaneously

execution of configuration:

- set the desired menu item by pushing the ▲- or ▼-button
- activate the set menu item by pushing both buttons simultaneously
- set the desired value or select one of the offered settings by using the ▲- or ▼-button
- store / confirm the set value/selected setting and exit the menu by pushing both buttons simultaneously

6.2 Configuration

The menu system is a closed system allowing you to scroll both forward and backward through the individual set-up menus to navigate to the desired setting item. All settings are permanently stored in an EEPROM and therefore available again even after disconnecting from the supply voltage. The structure of the menu system is the same for all types of devices, regardless of the number of contacts. However, they only differ by the number of menus. Following figure and the menu list shows all possible menus. On devices with 3-wire output 4 ... 20 mA and 0 ... 20 mA, the menus ZP and EP have special functions. The menu DP is not applied, as the decimal point is already factory set during production.

Please follow the manual meticulously and remember that changes of the adjustable parameters (switch-on-point, switch-off point, etc.) become only effective after pushing both buttons simultaneously and leaving the menu item.

6.3 Password system

To avoid a configuration by unauthorized persons, the possibility is given to lock the device by an access protection. More information is given in menu 1 of the menu list.

6.4 Configuration example of the analogue output for 4 ... 20 mA / 3-wire adjustable

By the menus ZP and EP, the analogue output can be configured. In the following, the function of these menus shall be made clear by an example. Assuming you have a device with a nominal pressure range 0 ... 400 bar by factory the following performance is set:

0 bar = 4.00 mA 200 bar = 12.00 mA 400 bar = 20 mA

If you change the value in the menu ZP from 0 to 20 and the value in the menu EP from 400 to 300, the following performance will appear:

20 bar = 4.00 mA 160 bar = 12.00 mA 300 bar = 20 mA

The values of ZP and EP are adjustable up to 1:5 of the nominal pressure range.

6.5. Description of hysteresis and compare mode

To invert the respective modes, you have to exchange the values for the switch-on and switch-off points.

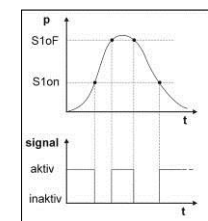

Fig. 4 compare mode

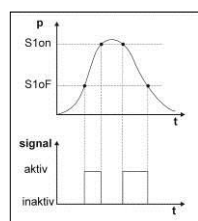

Fig. 5 compare mode inverted

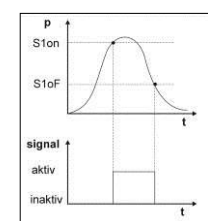

Fig. 6 hysteresis mode

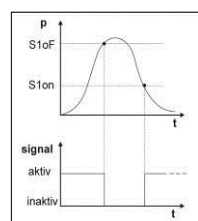

Fig. 7 hysteresis mode inverted

6.6 Menu list

✓ button functions are well known (see "6.1 Control and display elements")

PAon PAof	menu 1 – access protection PAon → password active → to deactivate: set password PAof → password inactive → to activate: set password default setting for the password is "0005"; modification of the password is described in special menu 4
dP	menu 2 – set decimal point position for devices with 3-wire output 4 ... 20 mA and 0 ... 20 mA the decimal point was already set during production
ZPdu	menu 2a – indication of the starting point, which was defined with the order (only 3-wire adjustable) no configuration is possible
EPdu	menu 2b – indication of the end point, which was defined with the order (only 3-wire adjustable) no configuration is possible
ZP EP	menus 3 and 4 – set zero point / end point the device has been configured correctly before delivery, so a later setting of a 2-wire device is only necessary, if a differing displayed value is desired (e. g. 0 ... 100 %) For devices with 3-wire output 4 ... 20 mA and 0 ... 20 mA this menu has a different meaning: The configuration of the zero point causes a changing of the analogue output, whereas the display value remains unchanged. (zero and end point can be configured within the limits of the nominal pressure range, according to the manufacturing label); for more information see "5.4 Configuration example of the analogue output for 3-wire-devices"
FILT	menu 5 – set damping this function allows getting a constant display value although the measuring values may vary considerably; the time constant for a simulated low-pass filter can be set (0.3 up to 30 sec permissible)
HILo	menu 6 – exceeding message set "on" or "off"
S1on	menus 7, 9, 11 and 13 – set switch-on points set the particular values, for the activation of contact 1 (S1on) up to 4 (S4on)
S1of	menus 8, 10, 12 and 14 – set switch-off points set the particular values, for the deactivation of contact 1 (S1of) up to 4 (S4of)
HY 1 CP 1	menus 15 up to 18 – select hysteresis or compare mode select the hysteresis mode (HY 1 up to HY 4) or compare mode (CP 1 up to CP 4) for the contacts 1 up to 4 (no. corresponds to the contact) compare "6.5. Description of hysteresis and compare mode"
d1on	menus 19, 21, 23 and 25 – set switch-on delay set the particular value of the switch-on delay after reaching switch-on point 1 (d1on) up to 4 (d4on) (0 up to 100 sec permissible)
d1of	menus 20, 22, 24 and 26 – set switch-off delay set the particular value of the delay after reaching the switch-off point 1 (d1of) up to 4 (d4of) (0 up to 100 sec permissible)
HIPr LoPr	menus 27 and 28 – maximum / minimum pressure display view high pressure (HIPr) or low pressure (LoPr) during the measurement process (the value will not remain stored if the power supply is interrupted) to erase: push both buttons again within one second
dLdS	menu 29 – measured value update (display) set the length of the update cycles for the display (0.0 up to 10 sec permissible)
TES 1	menu 30 up to 33 – simulate contacts (only 4 ... 20 mA / 3-wire adjustable) with the ▲- or ▼-button the contacts 1 (TES1) up to 4 (TES4) can be activated or deactivated
TESA	menu 34 – simulate analogue output (only 4 ... 20 mA / 3-wire adjustable) select one of the following settings: "oi 4" (4 mA or 2 V), "oi12" (12 mA or 6 V) and "oi20" (20 mA or 10 V)
ErS	menu 35 – error signal definition (only 4 ... 20 mA / 3-wire adjustable) set the desired error signal (this is given out in case of a defect); permissible settings are "OFF" (no error signal output), "C 0" (0 mA or 0 V), "C L0" (3.5 mA or 1.75 V) and "C HI" (23 mA or 11.5 V) an output of the error signal is only given when menu 6 is set on "on"
POS 1	menu 36 – offset compensation / position correction (only 4 ... 20 mA / 3-wire adjustable) confirm menu item "POSI"; if offset ≠ ambient pressure it is necessary to place the device under pressure pended on mounting position (pressure reference has to corresponding to the zero point of the pressure measuring range); push both buttons; "oF I" will be appeared in the display; push both buttons; in the display "Pro2" will be appeared; push both buttons; in the display "o" will be appeared; now the reference value can be inputted by using both buttons; the reference value is for instance 5% (-0.2bar) of metering range: -1 ... 15 bar; insert 5 (5%) by using both buttons; then push both buttons; in the display "oF5" will be appeared; accordingly the right and stable pressure (see instance -0.2bar) must be fed. If the measured value shown in the display is a wrong value, the operating sequence must be retreated. a position correction is necessary, if the installation position differs from the calibration position (otherwise this can cause a little deviation of the signal, which gives a wrong value indication) the analogue output signal (for devices with analogue output) is not affected by this change; when displacing the offset, the full scale will also be displaced
FAct	menu 37 – load defaults (only 4 ... 20 mA / 3-wire adjustable) to load the defaults, push both buttons simultaneously, after confirming the menu item any changes carried out will be reset (password will be set on "0005")
LoAd	menu 38 – load configuration (only 4 ... 20 mA / 3-wire adjustable) to load a stored configuration (via menu 39), set the desired number 1 up to 5
Stor	menu 39 – store configuration (only 4 ... 20 mA / 3-wire adjustable) to store a configuration, set the desired number 1 up to 5
special menus (to access a special menu, select the menu item "PAof" with the ▲- or ▼-button and confirm it; "1" appears in the display)	
FS S	special menu 1 – full scale compensation for full scale compensation, which is necessary if the indicated value for full scale differs from the real full scale value in the application; a compensation is only possible with a respective reference source, if the deviation of the measured value is within defined limits; set "0238"; confirm with both buttons; "FS S" will appear in the display; now it is necessary to place the device under pressure (the pressure must correspond to the end point of the pressure measuring range); push both buttons, to store the signal being emitted from the pressure switch as full scale; in the display the set end point will appear although the full scale sensor signal is displaced. the analogue output signal (for devices with analogue output) is not affected by this change
oF S	special menu 2 – offset compensation / position correction (not with 4 ... 20 mA / 3-wire adjustable) set "0247"; the menu description is identical with menu "POSI" (menu 36) for 3-wire-devices
LoAd	special menu 3 – load defaults (not with 4 ... 20 mA / 3-wire adjustable) set "0729"; the menu description is identical with menu "FAct" (menu 37) for 3-wire-devices
SETP	special menu 4 – set password set "0835"; confirm with both buttons; "SETP" appears in the display; set the password using the ▲- or ▼-button (0 ... 9999 are permissible, the code numbers 0238, 0247, 0729, 0835 are exempt); confirm the password by pushing both buttons simultaneously

6.7 Structure of the menu system

standard 2-/3-wire-system (version P07)

4 ... 20 mA / 3-wire adjustable (version P07):

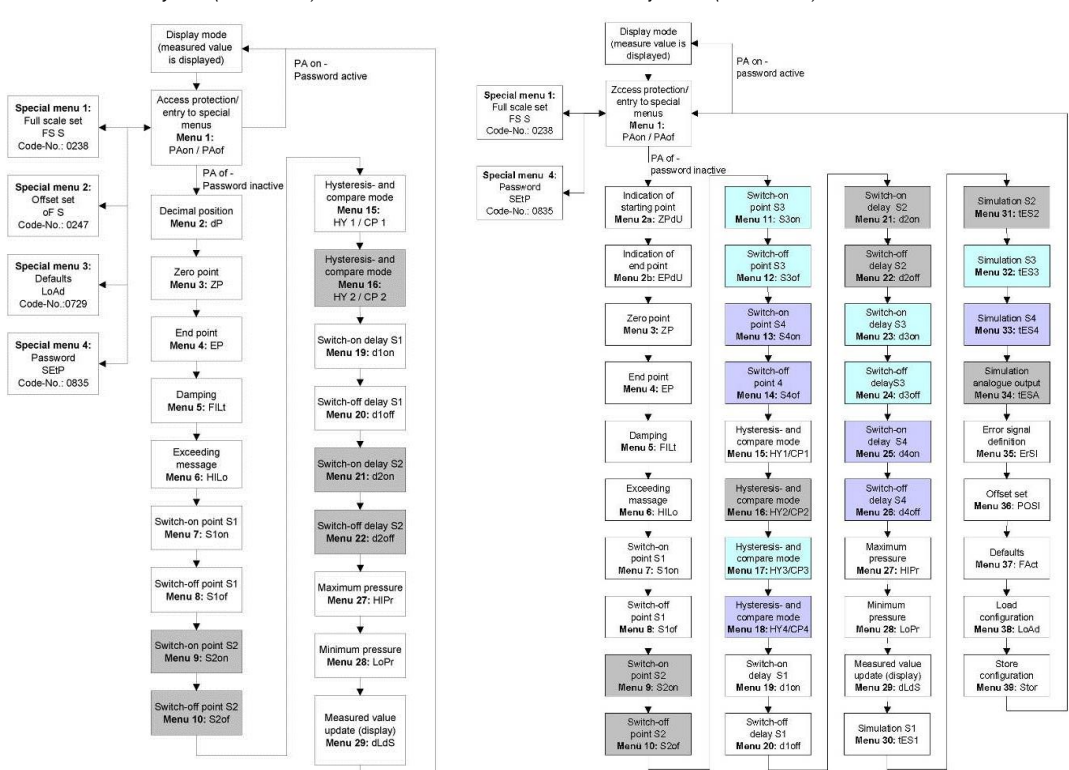

7. Maintenance

DANGER	Danger of death from airborne parts, leaking fluids, electric shock - Always service the device in a depressurized and de-energized condition!
WARNING	Danger of injury from aggressive fluids or pollutants - Depending on the measured medium, this may constitute a danger to the operator. - Wear suitable protective clothing e.g. gloves, safety goggles.

If necessary, clean the housing of the device using a moist cloth and a non-aggressive cleaning solution.

The cleaning medium for the media wetted parts (pressure port / diaphragm / seal) may be gases or liquids which are compatible with the selected materials. Also observe the permissible temperature range according to the data sheet.

Permitted cleaning temperature for flush mounted 3A / EHEDG certified pressure ports:

acids / bases: max. 70 °C
steam: max. 150 °C / 60 min

Deposits or contamination may occur on the diaphragm / pressure port in case of certain media. Depending on the quality of the process, suitable maintenance intervals must be specified by the operator. As part of this, regular checks must be carried out regarding corrosion, damage to the diaphragm and signal shift.

If the diaphragm is calcified, it is recommended to send the device to BD SENSORS for decalcification. Please note the chapter "Service/Repair" below.

NOTE – Wrong cleaning or improper touch may cause an irreparable damage on the diaphragm. Therefore, never use pointed objects or pressured air for cleaning the diaphragm.

8. Removal from service

DANGER	Danger of death from airborne parts, leaking fluids, electric shock - Disassemble the device in a depressurized and de-energized condition!
WARNING	Danger of injury from aggressive media or pollutants - Depending on the measured medium, this may constitute a danger to the operator. - Wear suitable protective clothing e.g. gloves, goggles.

NOTE - After dismounting, mechanical connections must be fitted with protective caps.

9. Service / repair

Information on service / repair:

- www.bdsensors.de
- info@bdsensors.de
- service phone: +49 (0) 92 35 / 98 11 0

9.1 Recalibration

During the life-time of a device, the value of offset and span may shift. As a consequence, a deviating signal value in reference to the nominal pressure range starting point or end point may be transmitted. If one of these two phenomena occurs after prolonged use, a recalibration is recommended to ensure furthermore high accuracy.

9.2 Return

WARNING	Danger of injury from aggressive media or pollutants - Depending on the measured medium, this may constitute a danger to the operator. - Wear suitable protective clothing e.g. gloves, goggles.
----------------	---

Before every return of your device, whether for recalibration, decalcification, modifications or repair, it has to be cleaned carefully and packed shatter-proofed. You have to enclose a notice of return with detailed defect description when sending the device. If your device came in contact with harmful substances, a declaration of decontamination is additionally required.

Appropriate forms can be downloaded from our homepage. Download these by accessing www.bdsensors.de or request them: info@bdsensors.de | phone: +49 (0) 92 35 / 98 11 0

In case of doubt regarding the fluid used, devices without a declaration of decontamination will only be examined after receipt of an appropriate declaration!

10. Disposal

WARNING	Danger of injury from aggressive media or pollutants - Depending on the measured medium, this may constitute a danger to the operator. - Wear suitable protective clothing e.g. gloves, goggles.
----------------	---

The device must be disposed of according to the European Directive 2012/19/EU (waste electrical and electronic equipment). Waste equipment must not be disposed of in household waste!

NOTE - Dispose of the device properly!

11. Warranty terms

The warranty terms are subject to the legal warranty period of 24 months, valid from the date of delivery. If the device is used improperly, modified or damaged, we will rule out any warranty claim. A damaged diaphragm will not be accepted as a warranty case. Likewise, there shall be no entitlement to services or parts provided under warranty if the defects have arisen due to normal wear and tear.

12. EU declaration of conformity / CE

The delivered device fulfils all legal requirements. The applied directives, harmonised standards and documents are listed in the EC declaration of conformity, which is available online at: <http://www.bdsensors.de>.

Additionally, the operational safety is confirmed by the CE sign on the manufacturing label.